

Industrial Ethernet Solutions

PDE3702SBEN



ENGINEERING YOUR SUCCESS.

Industrial Ethernet Solutions

What is Industrial Ethernet?

About Industrial Ethernet

Industrial Ethernet (IE) is the use of Ethernet in an industrial environment to communicate activity on the network with protocols for automation and process control that provide real-time data with high communication transfer rates. Ethernet is a popular choice due to the availability of several protocols, broad market acceptance, a good degree of backwards compatibility and availability of rugged components (hardwired) which are typically protected from electrical noise. Protocols for Industrial Ethernet include EtherCAT, EtherNet/IP, PROFINET, POWERLINK, CC-Link IE, and Modbus TCP. Parker's Moduflex, H Series Micro and H Series ISO valves allow the user to connect to the Ethernet network through valve nodes.

The sample application below, illustrates the layout and bill of material for an Industrial Ethernet solution consisting of three valve banks with Ethernet input modules, a valve driver module, and Ethernet cables.

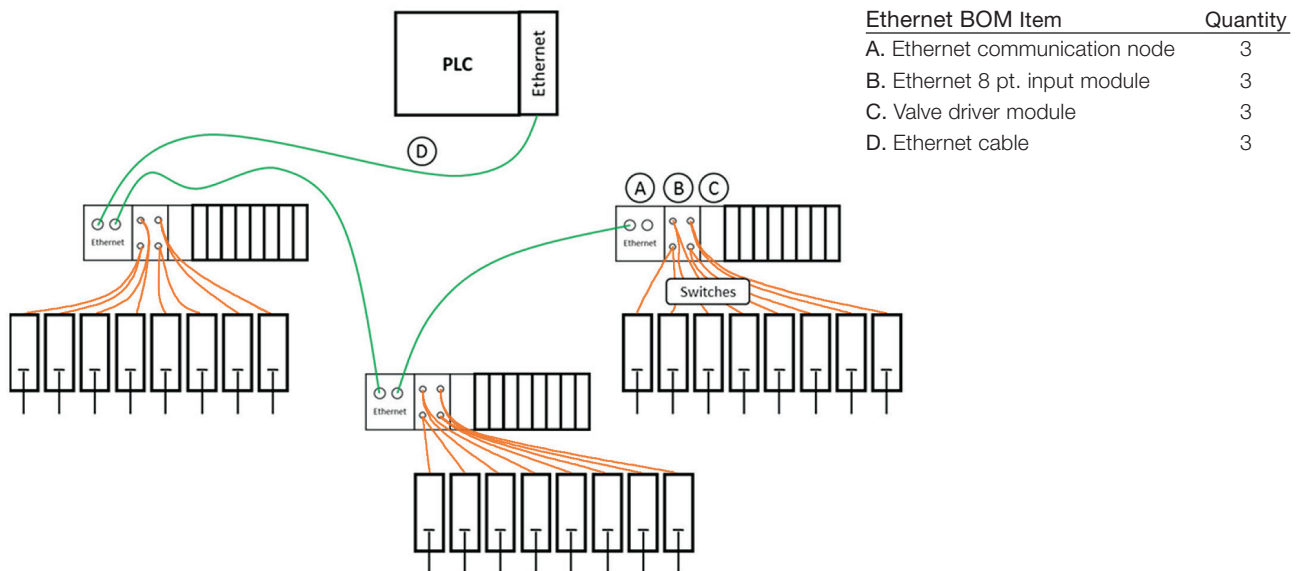

Industrial Ethernet Instead of Collective Wiring because:

- Ethernet brings I/O to the machine level
- Ease of wiring and simplicity of setup
- Labor is reduced when networked for troubleshooting, installation, and service

When to add IO-Link to the Industrial Ethernet Network

- When the application demands a large amount of I/O connections
 - fewer IP addresses
 - lower cost nodes required
 - standard proximity cables used
- When an open protocol is desired (supported by all PLC platforms)
- Installation time is reduced thus, saving labor
- Allows for easier troubleshooting and diagnostics

Overall

Aside from reducing installed labor costs due to ease of connection, Industrial Ethernet is easier to diagnose and operate because the network protocols communicate diagnostic information and process data through the PLC at a high rate. Predictive maintenance can be accomplished with ease, which reduces or eliminates downtime.

Industrial Ethernet Solutions

P2M Industrial Ethernet Node



The P2M Industrial Ethernet node is Parker's latest addition to the family of solutions for Industrial Ethernet connectivity. The design is optimized to be cost effective with the intention of providing the opportunity for customers with traditionally hardwired networks to migrate to an Ethernet solution that is intuitive, easy to use, install and maintain; all while reducing overall costs.

EtherNet/IP™



ETHERNET
POWERLINK

EtherCAT®



CC-Link IE Basic

Easy Connectivity

- Connects to three core valve products, Moduflex, H Micro and H Series ISO with flow range from Qn 175 to 5900 NL/mn
- 19 digital outputs on Moduflex valve series
- 24 digital outputs on H Series Micro and H Series ISO valve series

Easy Integration

- Embedded webpage included for easy monitoring and configuring purposes
- Compatible with PROFINET fast startup and EtherNet/IP quick connect
- No proprietary software required for connection

Intuitive and Predictive

- Simple diagnostic input data is provided over the network for easy troubleshooting and predictive maintenance
- Useful diagnostic flags in process (cyclic) data for easy access (voltage warnings, temperature warnings, communication error, solenoid short circuit error)
- Detailed diagnostic information in parameter (acyclic) data (voltage reading, configuration options and cycle count for each solenoid)

Safe Power Capable

The P2M Industrial Ethernet node has the auxiliary power galvanically isolated from the logic power. The P2M is safe power capable which allows for test pulse (OSSD) compatibility and can be supplied with auxiliary power from a safe output device (such as a safe relay) following machinery directives.

Right Sizing

The P2M node has a wide variety of available valve sizes and flow ranges to ensure the best fit to the machine design.



P2M on Moduflex



P2M on H Series Micro

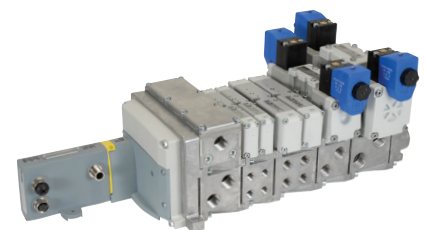

P2M on H Series ISO Universal Manifold

For more information visit us at www.parker.com/pde/networkconnectivity

Industrial Ethernet Solutions

Turck BL67 Network Portal

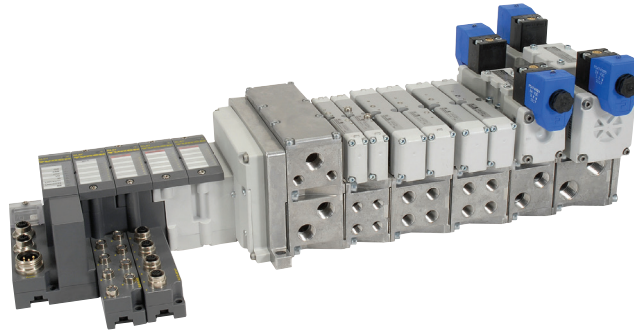

The Turck BL67 network portal is a complete network communication offering and is widely adopted for its broad range of connectivity options, vast array of network protocols and high density I/O modules. Made up of four primary components (the valve driver module, I/O modules, Communication modules and power distribution modules) the multi-functional network portal offers complete configurability for a multitude of applications.



Key Features

- Highly modular design including digital and analog I/O, RFID, IO-Link, and power distribution modules for a range of application needs
- Expandable 4 port Class A IO-Link master
- Channel-level diagnostics (LED and electronic) including open-wire detection, short-circuit detection, alarm with annunciation.
- Optical isolation between field and system circuits
- Robust design for high rigidity
- Electronic and mechanical keying
- Single part# Multi-protocol communication node that supports EtherNet/IP, PROFINET, and Modbus-TCP
- Programmable communication node allows simplification of PLC code by decentralizing control (IEC 61131-3 programming with free software using CoDeSys)

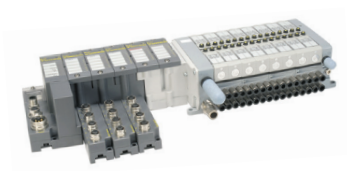

Turck on H Series Micro

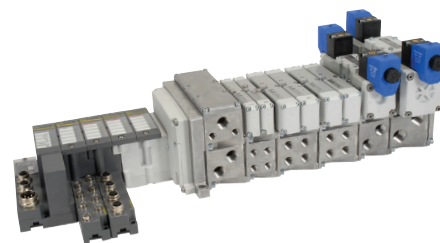

Turck on H Series ISO

For more information visit us at www.parker.com/pde/networkconnectivity

Industrial Ethernet Solutions

H Series Network Portal



The H Series Network Portal provides flexibility on machine for Ethernet applications. Designed to connect with H Series ISO and H Series Micro valves; the H Series Network Portal handles the Machine I/O eliminating the need for additional PLC input and output cards. **Preferred Connectivity** is available with Rockwell CompactLogix and ControlLogix PLC's. This means that the H Series Network Portal's module part numbers are listed in the Rockwell RSLogix 5000 PLC's software and simplifies the set-up process. Having the I/O on the valve manifold via the H Series Network Portal allows for easy centralized machine application even in caustic, wash down or hazardous areas with extreme temperatures.

EtherNet/IP™

DeviceNet™

PROFI[®]
BUS

ControlNet™

Key Features

- Preferred Connectivity to Rockwell Automation PLC's reduces configuration and setup time
- Digital or analog inputs / outputs available
- Eliminates the need for terminal strips and wire ways in the cabinet
- Max I/O per node - up to 256 I/O per H Series Network Node
- Bus expansion: H Series Micro only can be expanded up to 128 solenoid coils (see image below)
- Up to 32 solenoids for H Series Micro and H Series ISO from HB to H2 with Universal Manifold and up to 24 solenoids for H3 with Classic Manifold
- Reduces the installed cost of centralized machine design



H Series Network Portal on H Series ISO

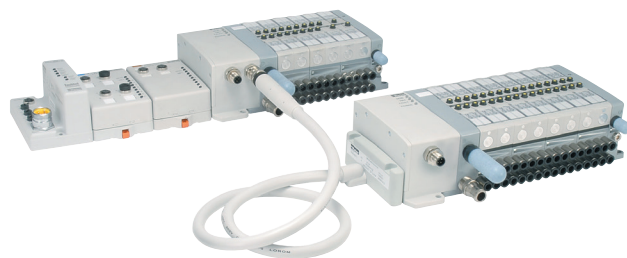

H Series Network Portal on H Series Micro with Bus Extender

For more information visit us at www.parker.com/pde/networkconnectivity

Industrial Ethernet Solutions

Industry Trends

Industrial Ethernet has an annual growth rate of 22% year over year and currently represents 52% of the market.

Industry 4.0 (the fourth industrial revolution) is an advancement in the manufacturing sector to have smarter, more connected factories of the future. The smart factory operates in real time with predictive maintenance and built in diagnostics on equipment. This revolution is a consolidation of technology bringing Cyber - Physical Systems (CPS) to the automation environment. Ultimately the goal of the smart factory is the elimination of downtime and the enhancement of productivity.

The Internet of Things (IoT) is a network of electronic devices. On a factory floor the devices connected to this global network are typically industrial devices. When used to connect industrial systems with a high level of robustness, reliability, security and real-time systems; the network is often called **The Industrial Internet of Things (IIoT)**.

Data Analytics on an Industrial Ethernet network productivity is enhanced with real-time control of the manufacturing process that captures and generate data to help with predictive maintenance and to make decisions based on accurate reporting of what's trending on the plant floor. Using analytics can be accomplished in many ways. Data for example can be stored and retrieved as needed (acyclic data) or sent back through the network in real-time for immediate attention (cyclic data).

The Shift to Industrial Ethernet Networks Today, several Industrial Ethernet protocols have been introduced and widely adopted by automation equipment manufacturers due to their advantages over traditional fieldbus networks. Industrial Ethernet protocols are now the fastest-growing deployed network type in new industrial installations with an annual growth rate of 22%.

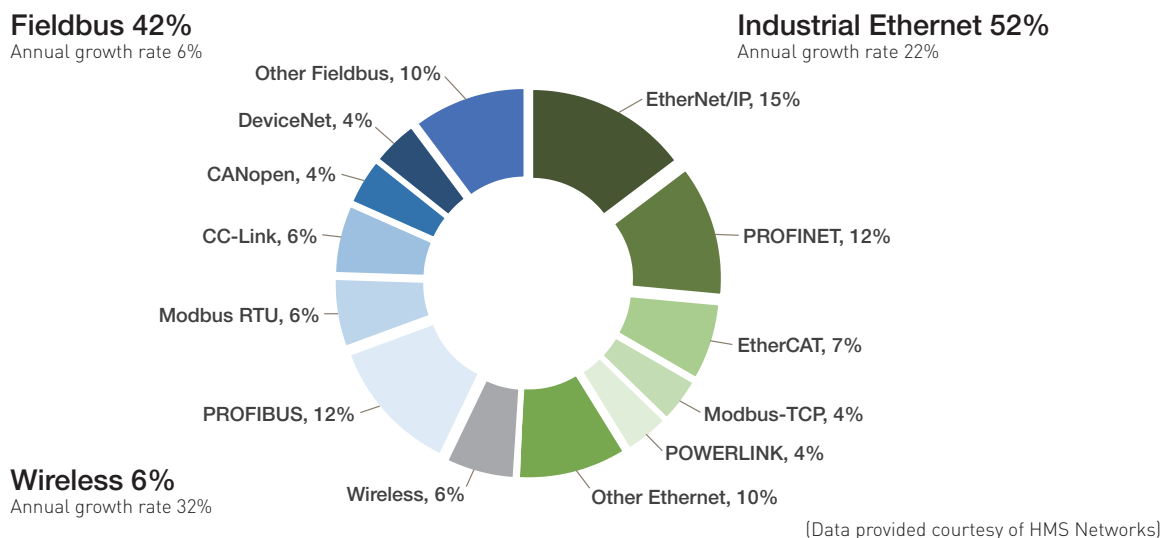

For more information visit us at www.parker.com/pde/networkconnectivity



EMEA Product Information Centre

Free phone: 00 800 27 27 5374

(from AT, BE, CH, CZ, DE, DK, EE, ES, FI, FR, IE, IL, IS, IT, LU, MT, NL, NO, PL, PT, RU, SE, SK, UK, ZA)

US Product Information Centre

Toll-free number: 1-800-27 27 537

www.parker.com